



URBAN GREEN INFRASTRUCTURE SOLUTIONS

TOTAL SOLUTIONS FOR SITE DEVELOPMENT AND MUNICIPAL APPLICATIONS

Chris Bogdan – Urban Green Infrastructure Business Development Manager





WHO ARE WE?



FERGUSON WATERWORKS LOCATIONS

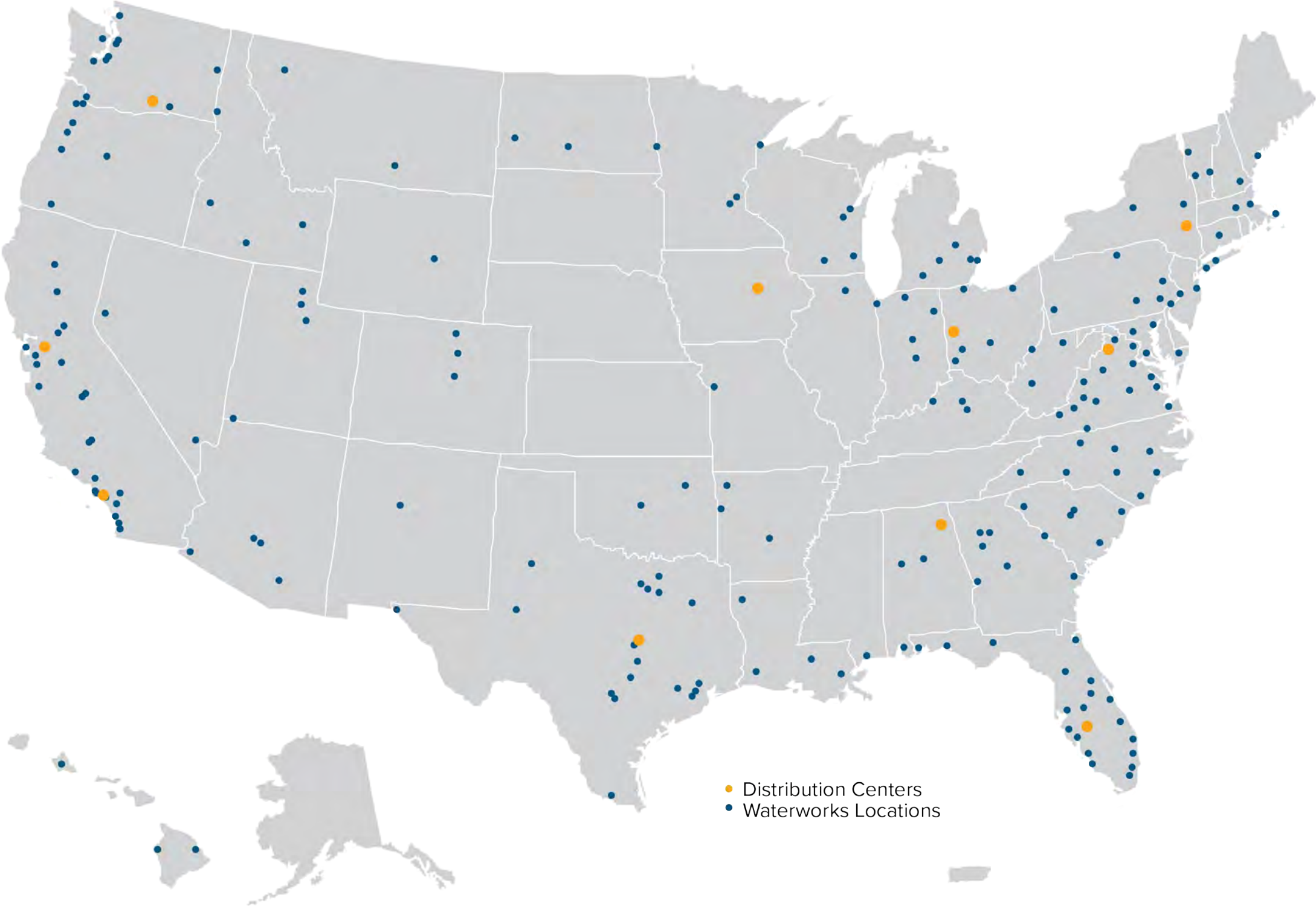

GEOSYNTHETICS, EROSION CONTROL AND STREAMS

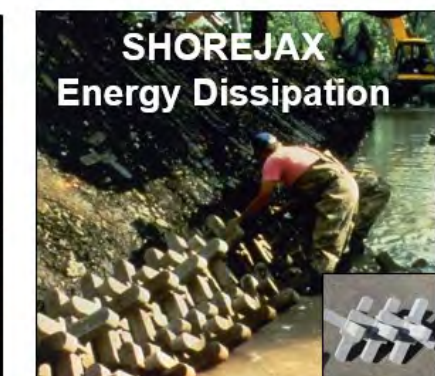
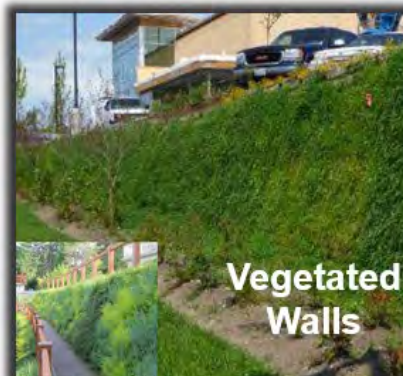
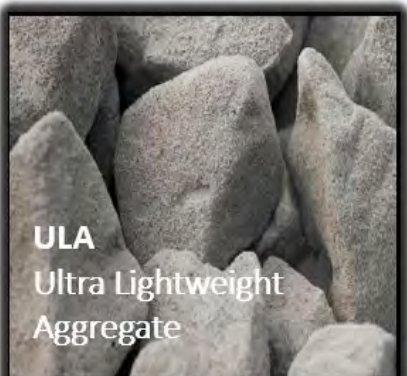
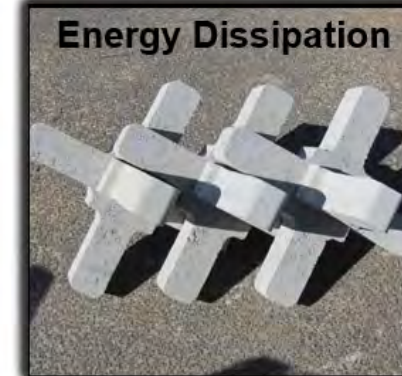
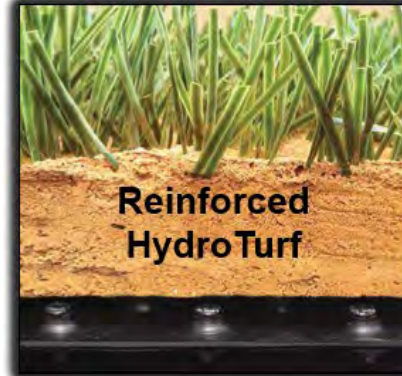
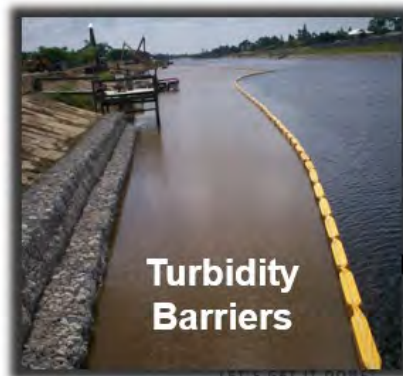
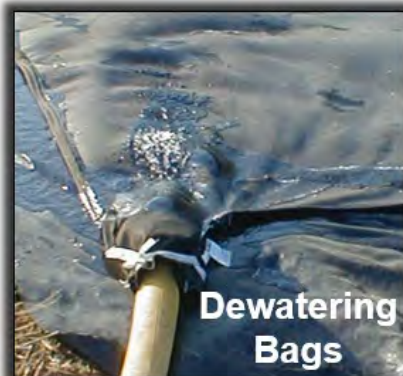

URBAN GREEN STORMWATER SOLUTIONS



STORMWATER SOLUTIONS

PRODUCT CATEGORIES

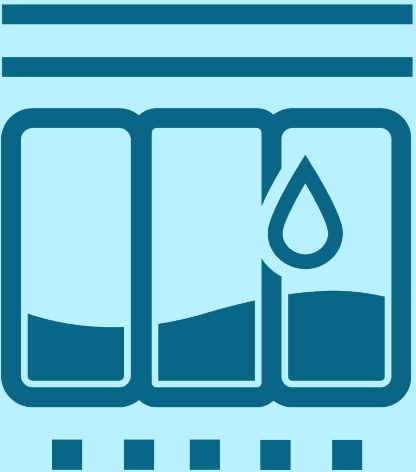

Space Efficient Storage

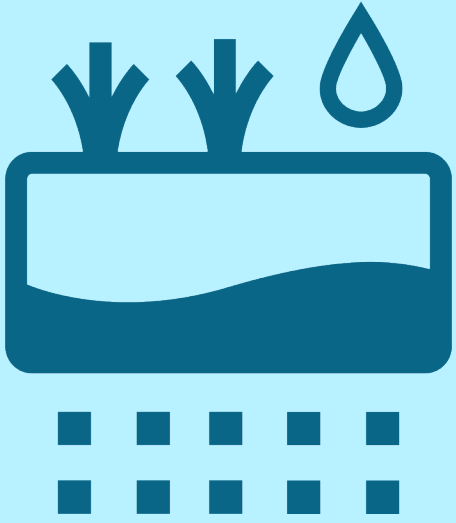

Media & Biofiltration

The 'Space Efficient Storage' icon shows three vertical rectangular tanks with a water level line and a single water drop above the rightmost tank. Below it is a row of five small squares. The 'Media & Biofiltration' icon shows a rectangular tank with a wavy water level line, two downward-pointing arrows above it, and a single water drop to the right. Below it is a 2x5 grid of small squares.



Filters & Screens

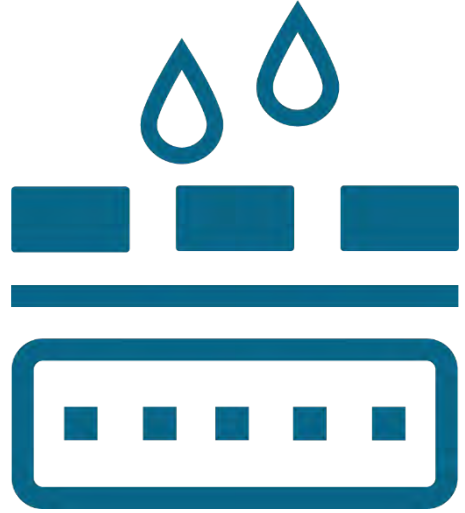

Alternative Surfaces

FOCALPOINT

MODULAR BIOFILTRATION SYSTEM

- Space efficient
- 100 in/hr innovative media
- Provides treatment for a variety of pollutants
- Engineered system

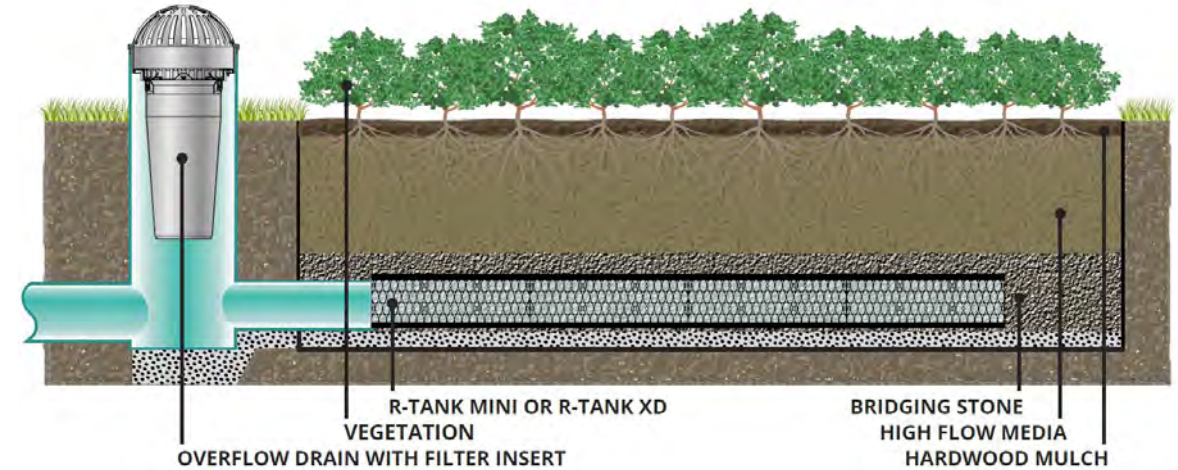

- Smaller footprint = less disturbance
- Smaller footprint = smaller maintenance footprint
- Smaller footprint = feasibility in tight spaces previously overlooked

THE SECTION

FOCALPOINT

Vegetated System:
Plants process pollutants removed from run-off and root system maintains drainage and aeration of media.

3" Layer of Shredded Hardwood Mulch:
Pre-treatment mechanism.
Removal and Replacement of Mulch Represents the Bulk of System Maintenance!

6" Bridging Stone & Separation Layer:
Clog-Proof Clean Stone & Micro-Mesh Replace Traditional Geotextile Layer
No geotextile = no clogging

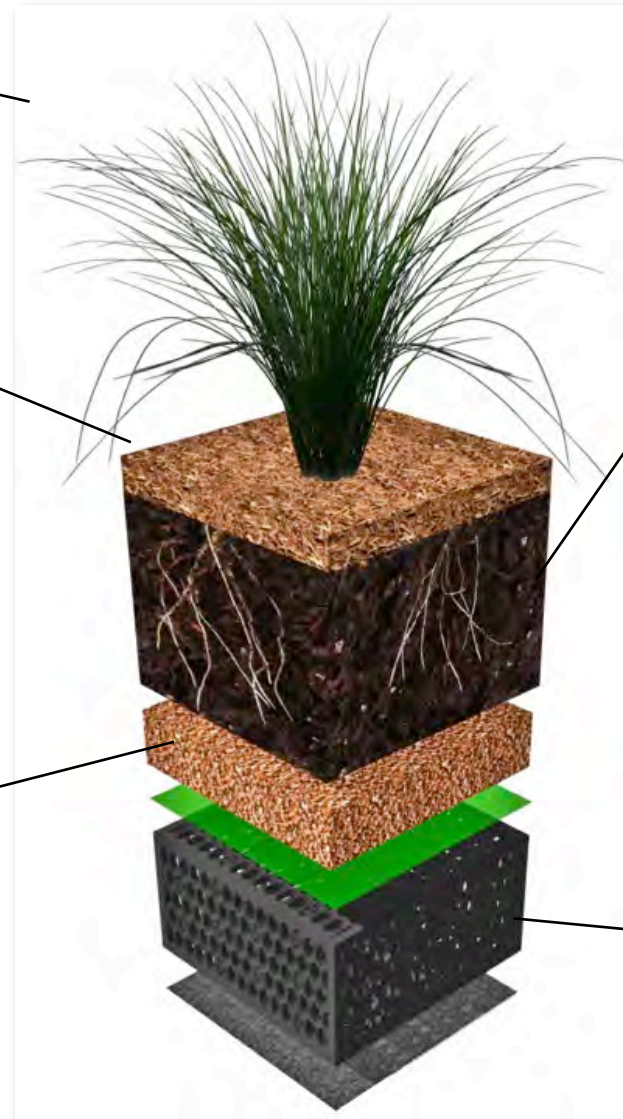

18" High Performance Media:

Flows at 100" Per Hour /
200 ft per day
Resistant to Clogging

Pollutant Removal (Full scale 3rd party TAPE field test):

TSS = 91%
Nitrogen = 48%
Phosphorus = 66%

High Performance Underdrain:

9.45" Modular Tank, or "Flat Pipe"
w/95% Open Surface Collects Water Efficiently.

Optional 2" Low-Profile Panel
Addresses Shallow Applications.

Expand into Modular Tanks for
Larger Storage
Needs.

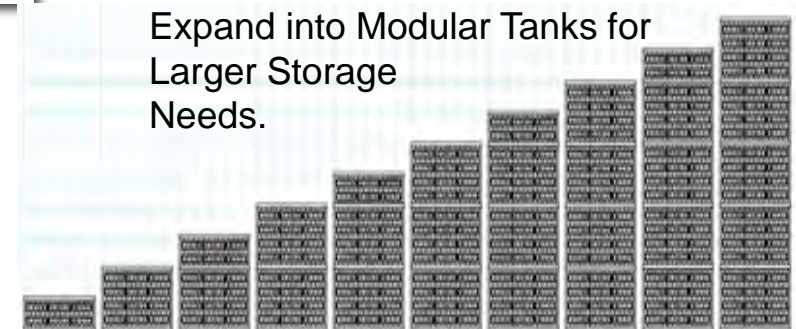

R-TANK

MODULAR SUBSURFACE STORAGE SYSTEM

- 95% void space
- Minimize excavation, maximize storage
- Preassembled
- Shallow Groundwater
- Overcome unexpected utilities in field
- Detention and Infiltration
- Excess Capacity for Resilience

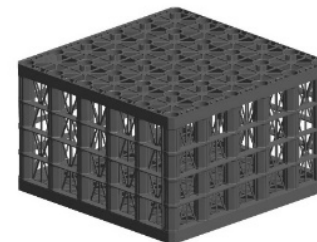

MODULAR VERSATILITY



MODULE HEIGHTS AND MIN COVER FOR TRAFFIC LOADING

Standard R-Tank Modules:

- Depth = 9.45" to 83.46"
- Storage = 2.30 cf to 20.34 cf

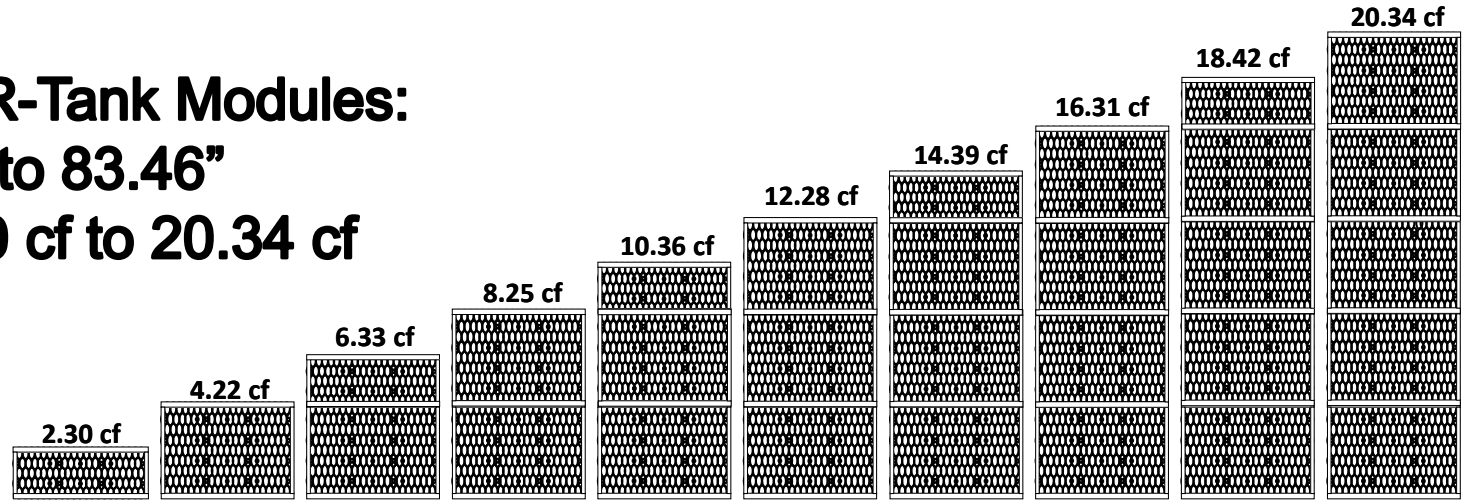

Min 20"
Max 7 ft



Min 18"
Max 10 ft

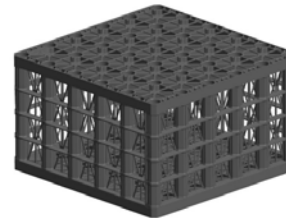

Min 12"
Max 5 ft



Min 6"
Max 16 ft

SIZING

FOCALPOINT

**Same
Volume and
Treatment
Capacity**

**Traditional Bioretention Design:
2"- 5" Per Hour / 4' to 10' Per Day
Bioretention Mix**



**Same
Volume and
Treatment
Capacity**



= Media Treatment Footprint

**FocalPoint
100" Per Hour / 200' Per Day
Biofiltration Mix**

— = Water Quality Volume — = FocalPoint Treatment — = Volume > WQv to bypass

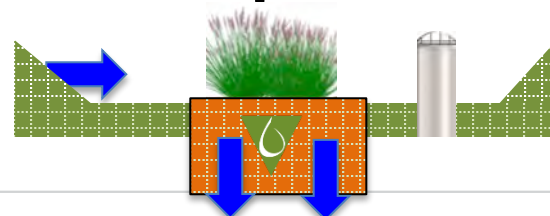
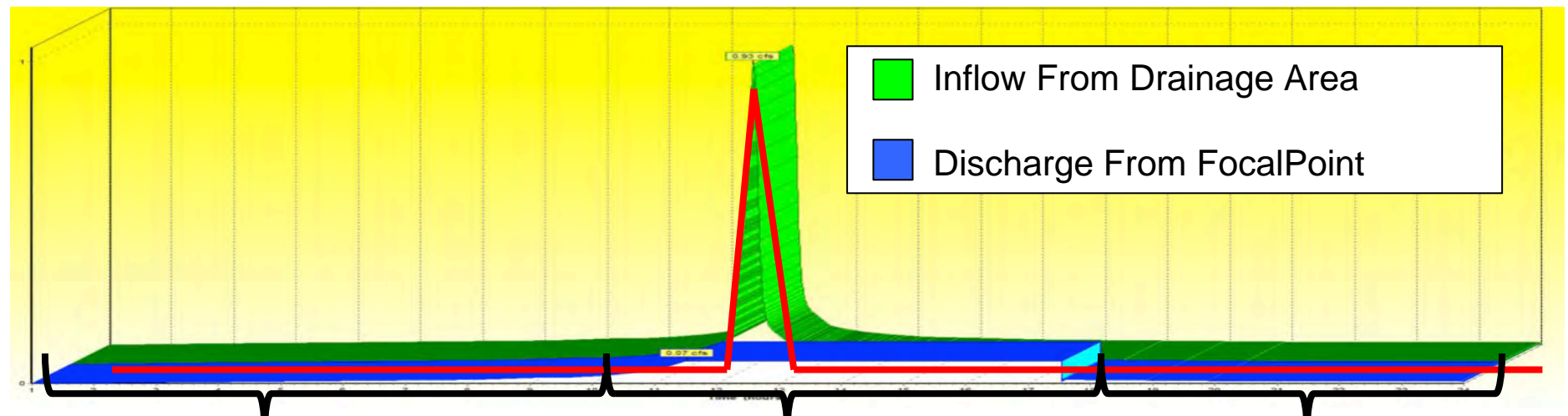

During run-up to peak
= Flow thru device.



Peak volume is stored in the
surface depression.

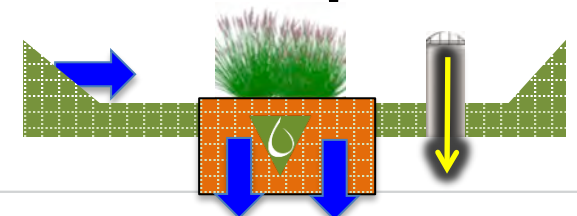

After peak = Flow thru device.
Excess runoff goes to bypass

EXPANDED STORAGE

FOCALPOINT

HPMBS extended storage options provide great versatility for a variety of applications:

Infiltration

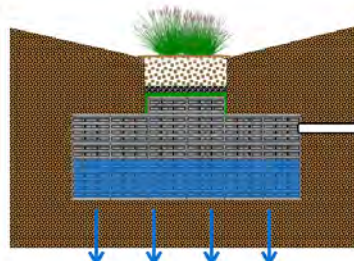

Detention

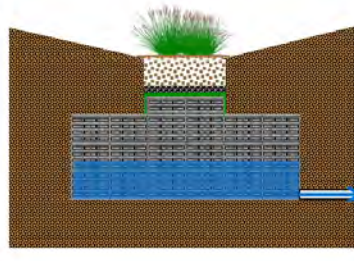

Harvesting / Reuse (Lined System)

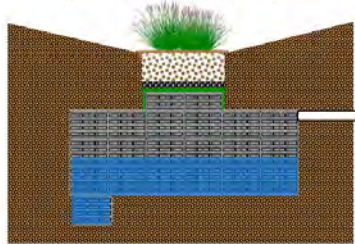

Combinations

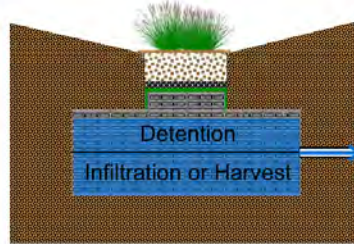

In-Line Treatment (Treat and Release)

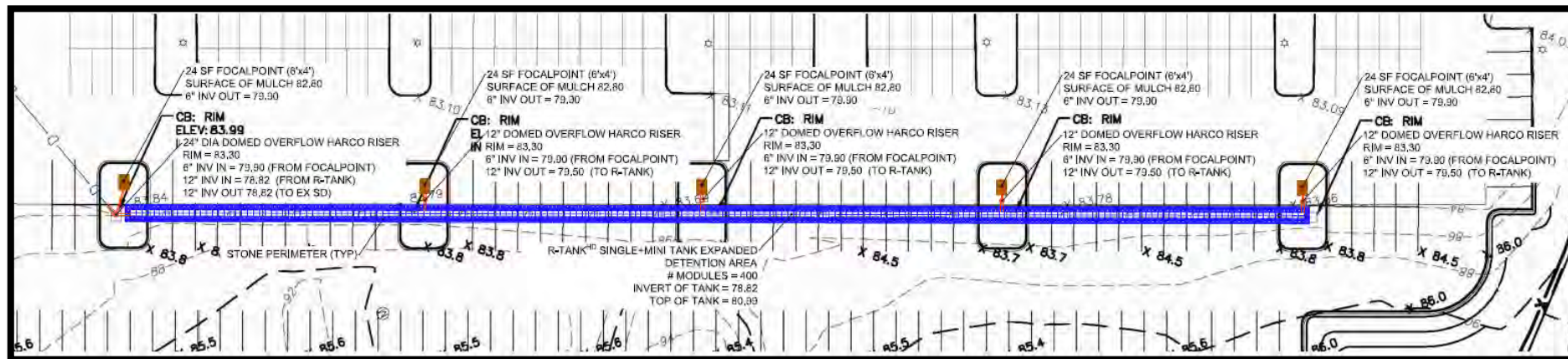
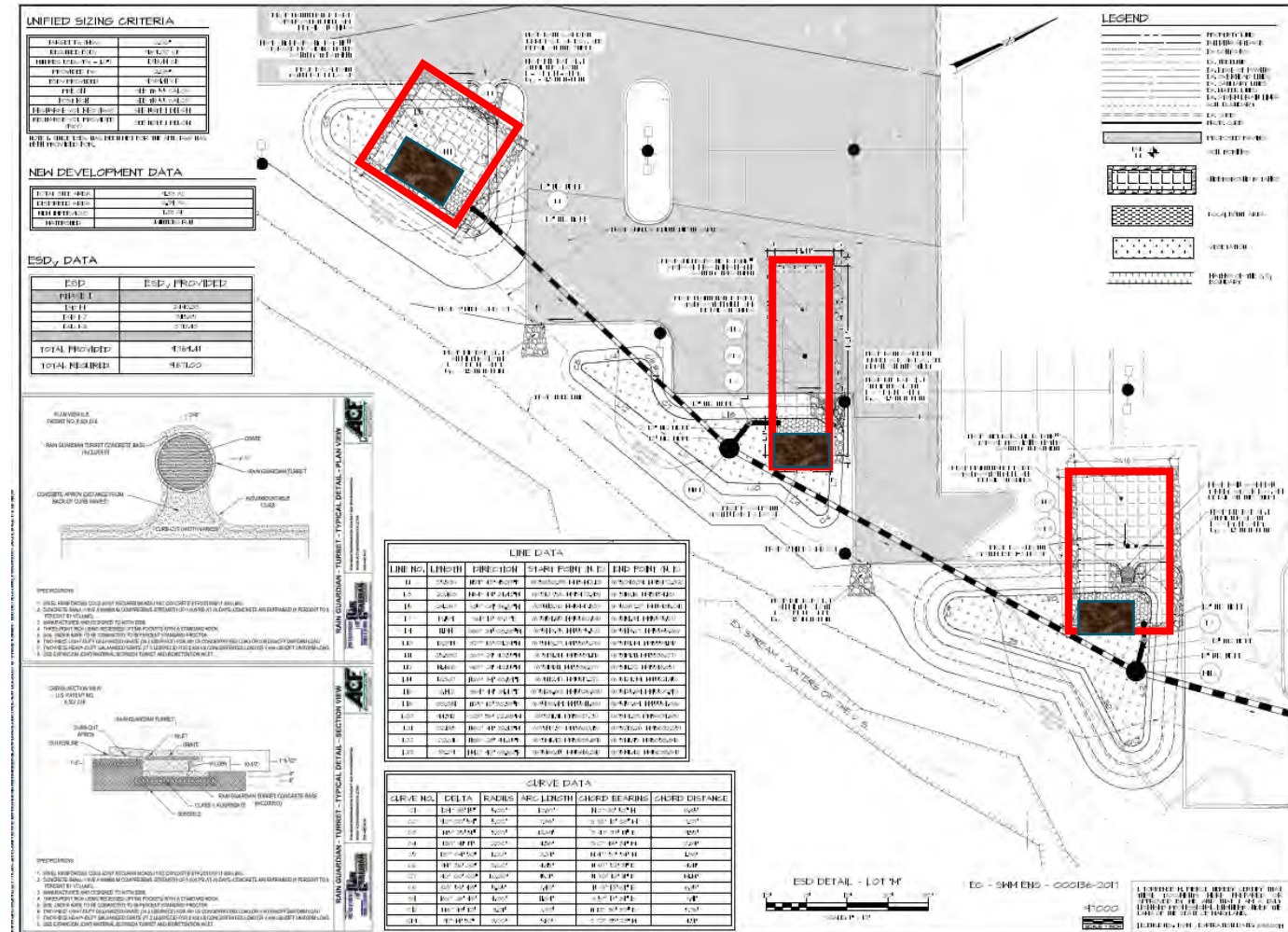
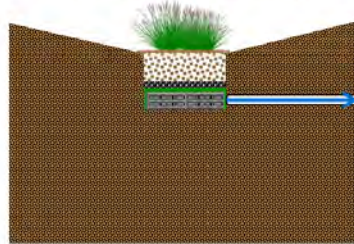

DESIGN EXAMPLES

FOCALPOINT BIOFILTER

Upper Chesapeake Medical Campus – Bel Air, MD

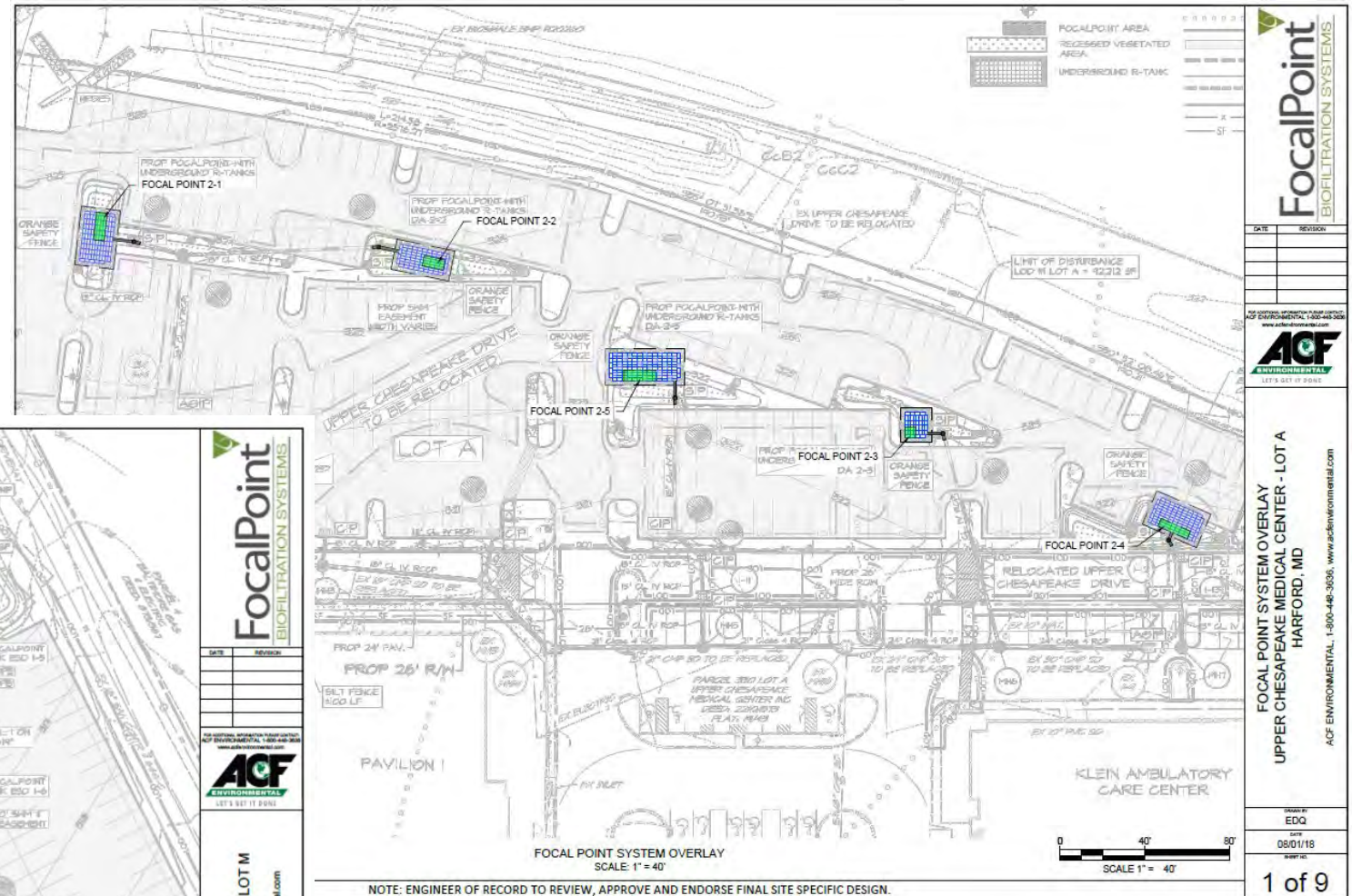
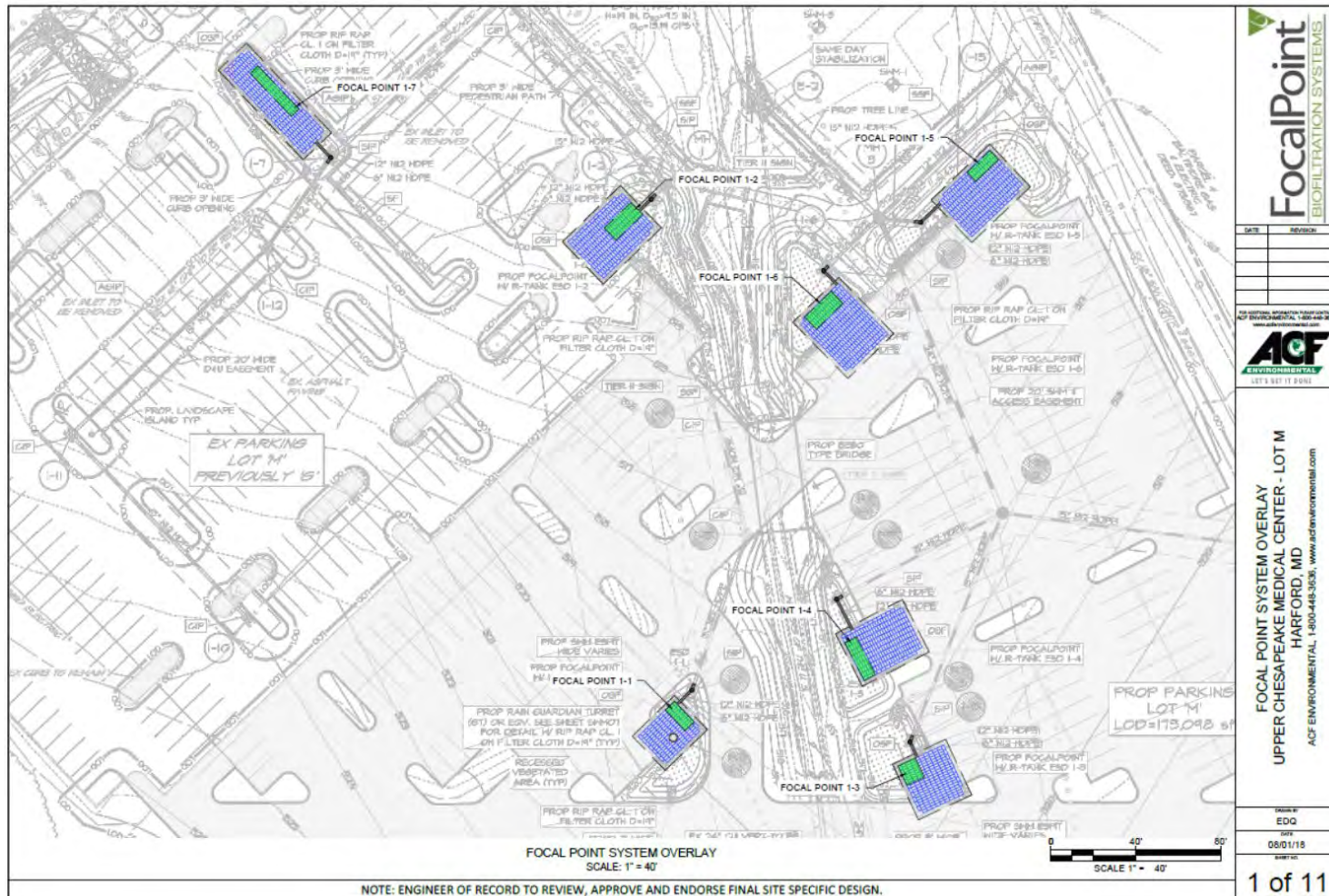

FocalPoint
BIOFILTRATION SYSTEMS

ACF
ENVIRONMENTAL
LET'S GET IT DONE

FOCAL POINT SYSTEM OVERLAY
UPPER CHESAPEAKE MEDICAL CENTER - LOT A
HARFORD, MD
ACF ENVIRONMENTAL 1-800-448-3036 www.acfenvironmental.com

INSTALLATION

FOCALPOINT

- Maximum flexibility
- Easy Installation
- Oversight
- Protected until project complete



INSTALLATION

FOCALPOINT BIOFILTER

The Wexley At 100 - Howard County, MD



MAINTENANCE

FOCALPOINT

- Cleaning of pretreatment device
- Removal of weeds and manage vegetation
- Remove and replace mulch layer



CURBLINE GREEN INFRASTRUCTURE

GOALS OF GSI

- Look amazing (aesthetics)
- Filter Pollutants (water quality)
- Be Maintenance Free (good luck 😊)
- Be able to handle a layer of trash and sediment

That's pretty much impossible – but using pretreatment devices gets us much closer!

* Energy Dissipation



* Collection of sediment/debris



SURFACE BMP PRETREATMENT

TWO OPTIONS

TWO OPTIONS

Watershed Area < 0.25 acres

Rain Guardian

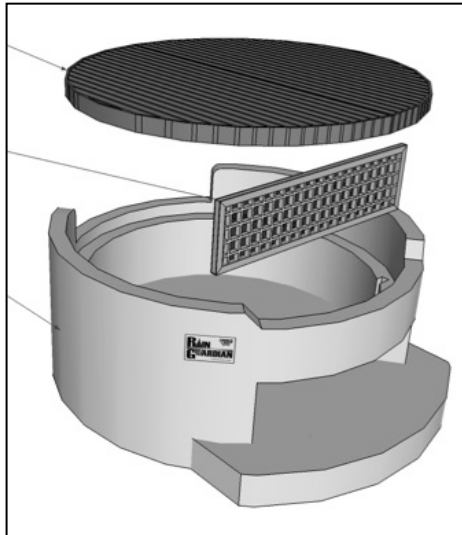

Watershed Area > 0.25 acres

PreTx

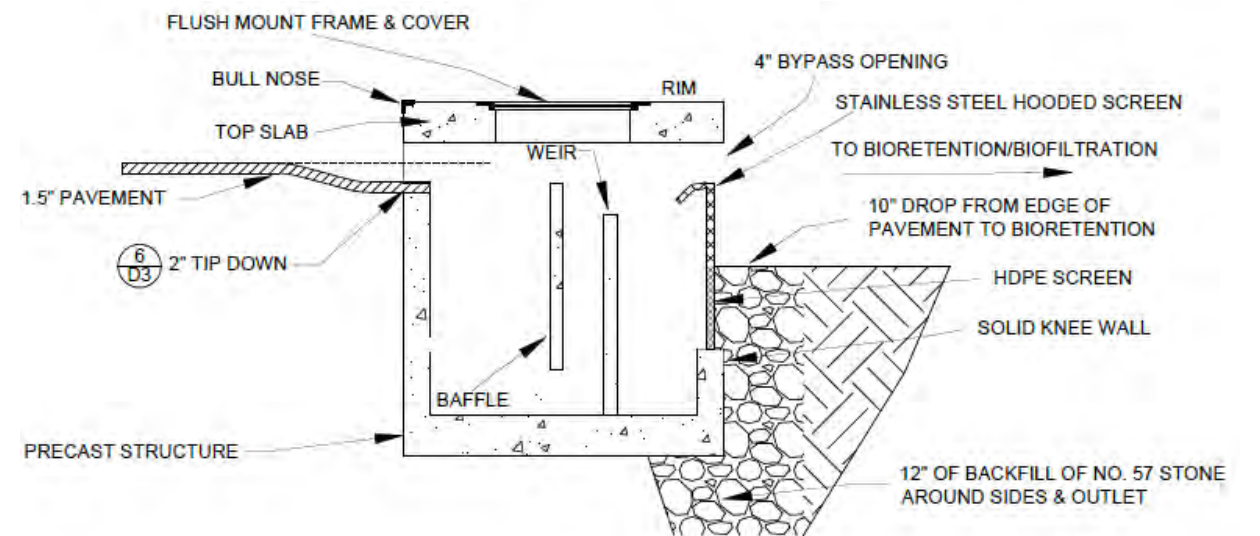

RAIN GUARDIAN <math>< 1/4</math> ac

“TURRET”

- Extend Effective Bioretention Cell Life
- Maximize Capacity
- Easy Installation
- Simplify Maintenance

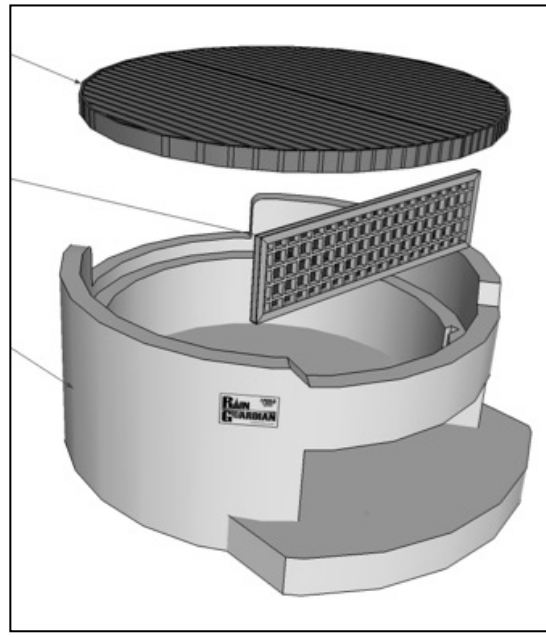

“FOXHOLE” (where there is sidewalk)

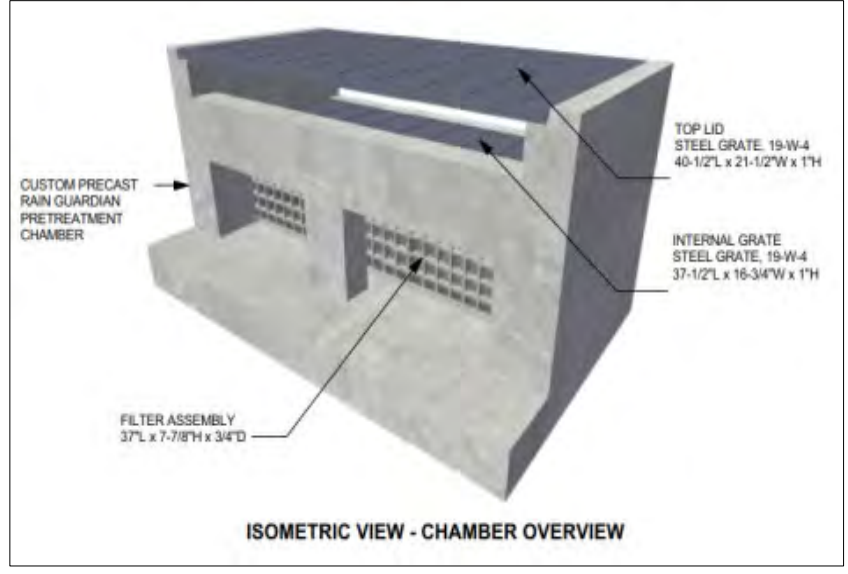
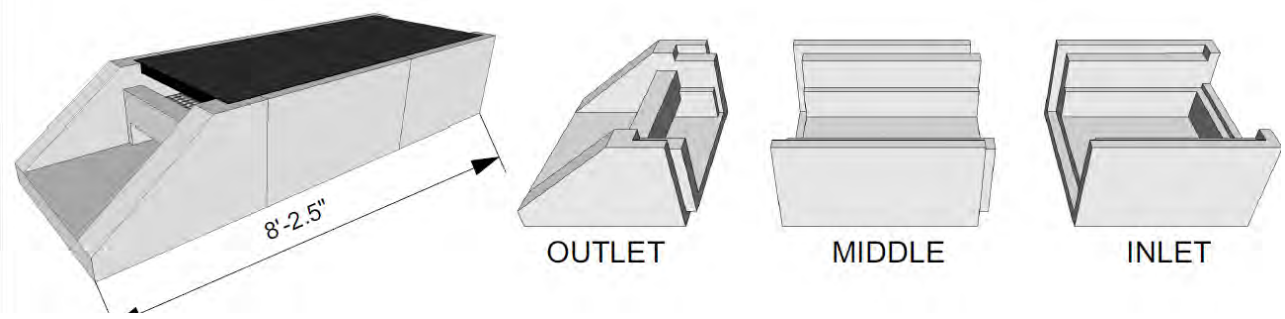

PRETX > 1/4 ac

PRETREATMENT DEVICE

- Larger watersheds
- Higher volumes of sediment
- Formal sump and storage
- Baffles, weirs and screens

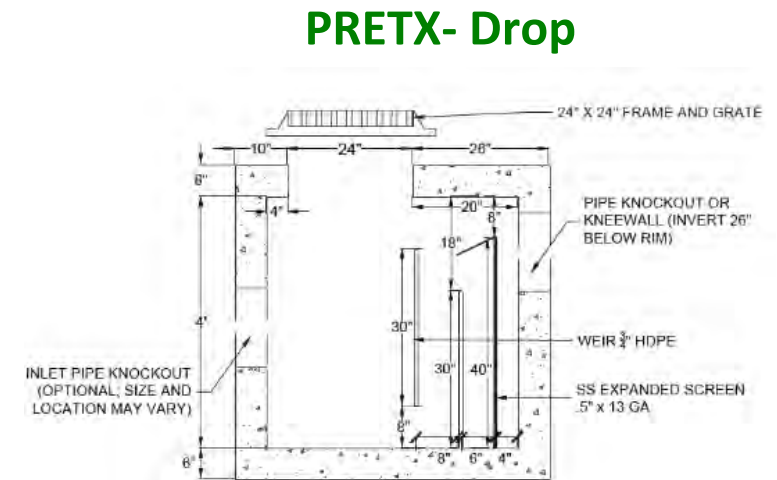
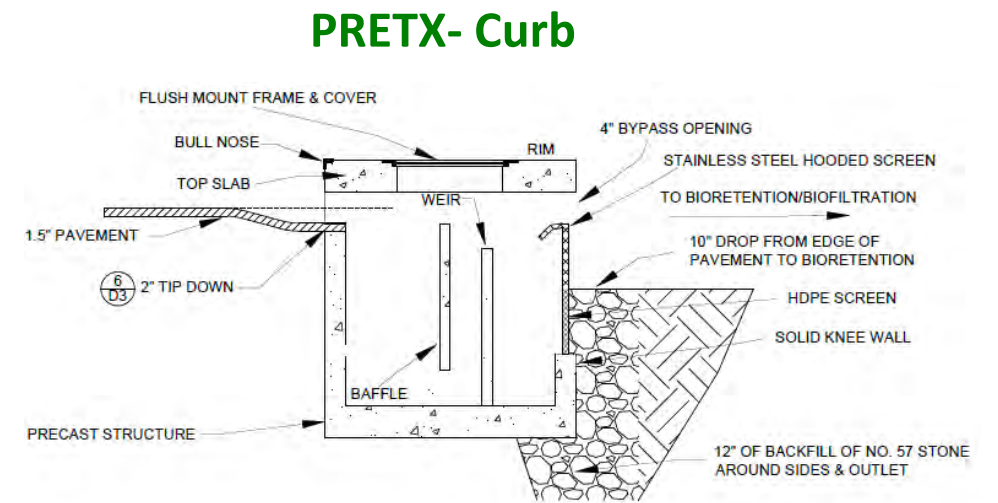

GREEN INFRASTRUCTURE BYPASS

DOMED OVERFLOW WITH FILTER INSERT

- Conveyance of larger storms
- Collection of floatables, mulch, debris
- Expanding ring mount
- No screws or fasteners
- Low cost
- Easy to clean

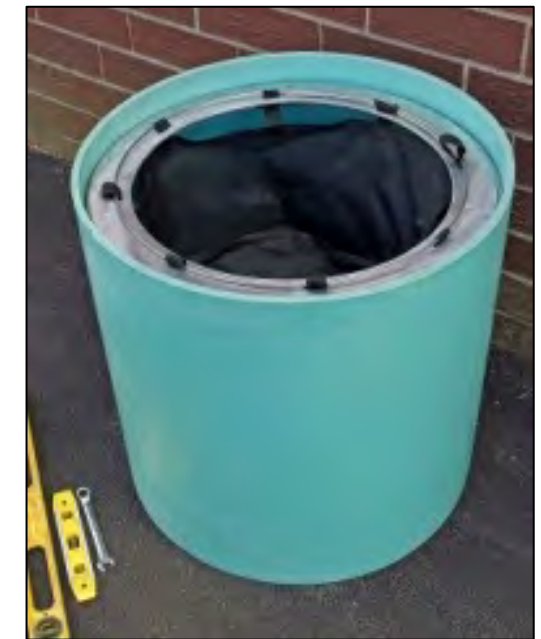
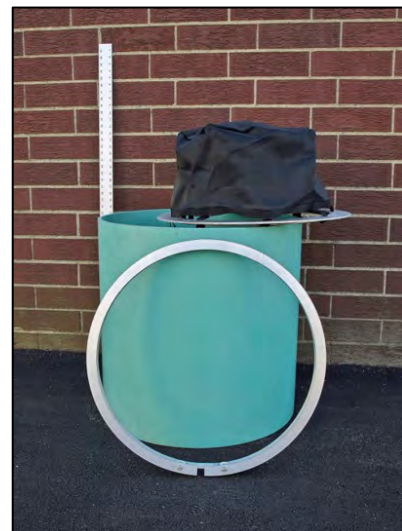
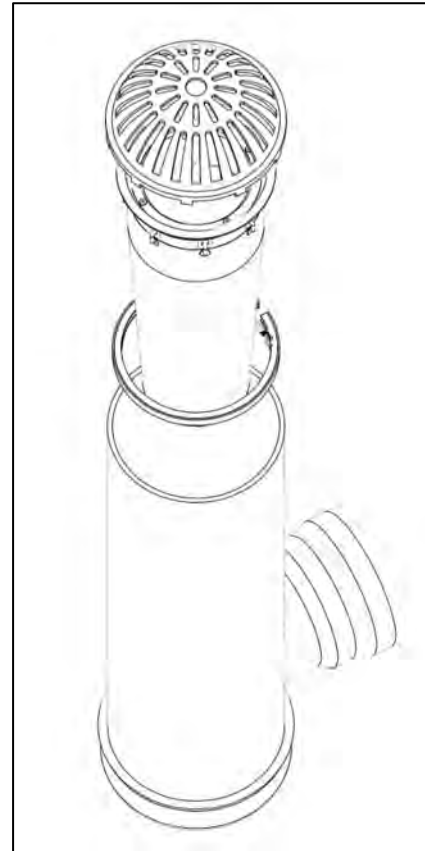

CAR DEALER DEVELOPMENT

FOCALPOINT BIOFILTER



HIGH PROFILE RETAIL

FOCALPOINT BIOFILTER



INFILL HOUSING

FOCALPOINT BIOFILTER WITH EXPANDED R-TANK



TIGHT URBAN SITES

FOCALPOINT BIOFILTER

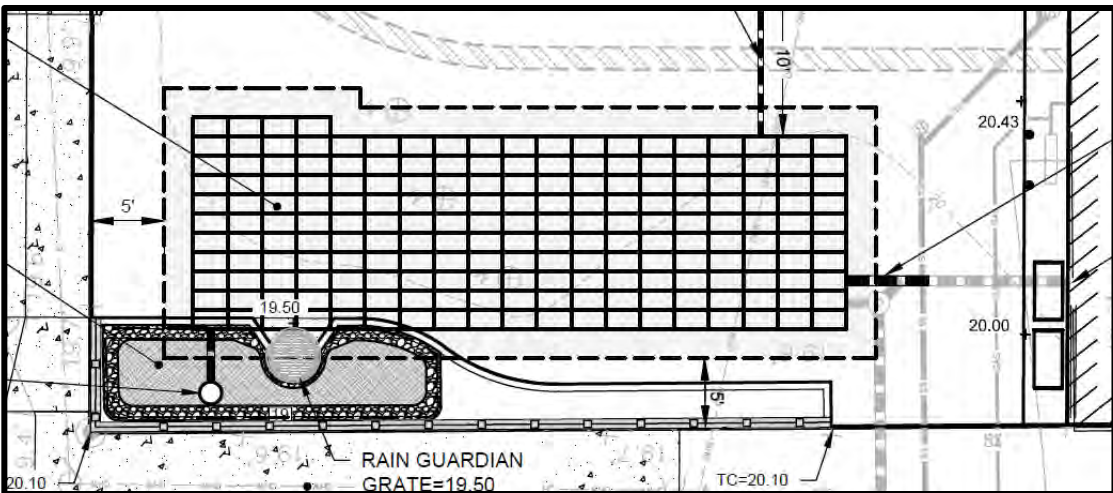

ASCE HQ SUSTAINABLE PARKING PROJECT

RESTON VA



GREEN STREETScape PROJECTS

PWSA PITTSBURGH



STEPPED/TERRACED R-TANK SYSTEM w NO RAIN GARDEN - OPTION 2

USE 'UPTURNED ELBOWS' TO ARTIFICIALLY FILL UPPER TANK SET FIRST (MINIMIZES "SHORT CIRCUITING")

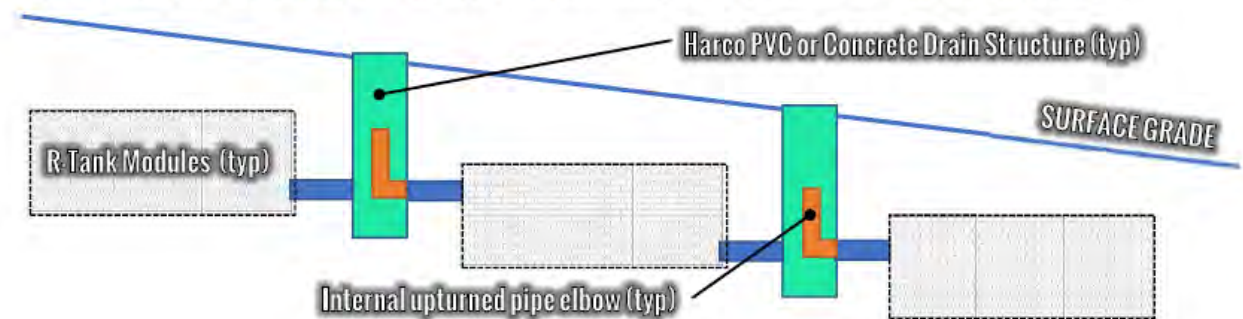

GREEN ROADWAY PROJECTS

FOCALPOINT BIOFILTER

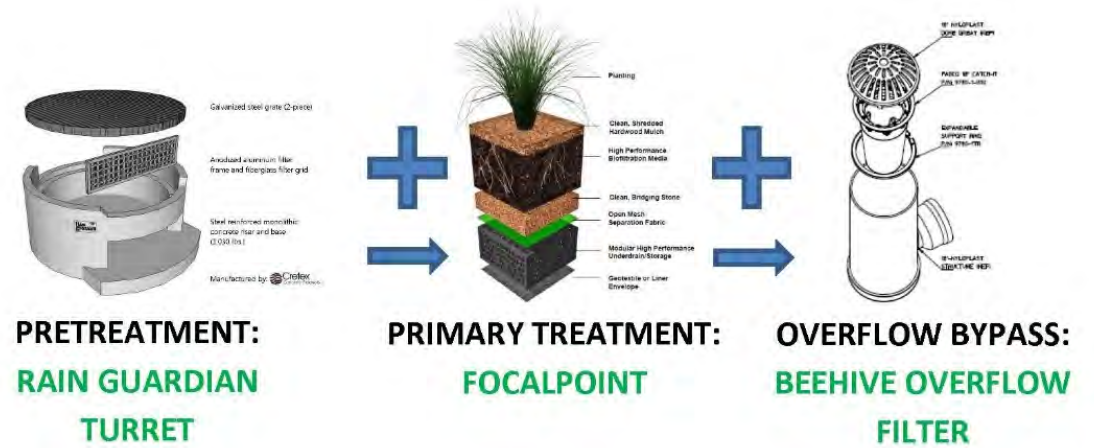

GREEN ROADWAY PROJECTS

PITTSBURGH

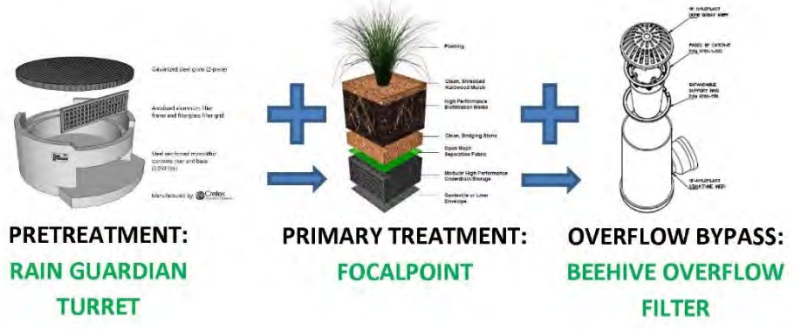
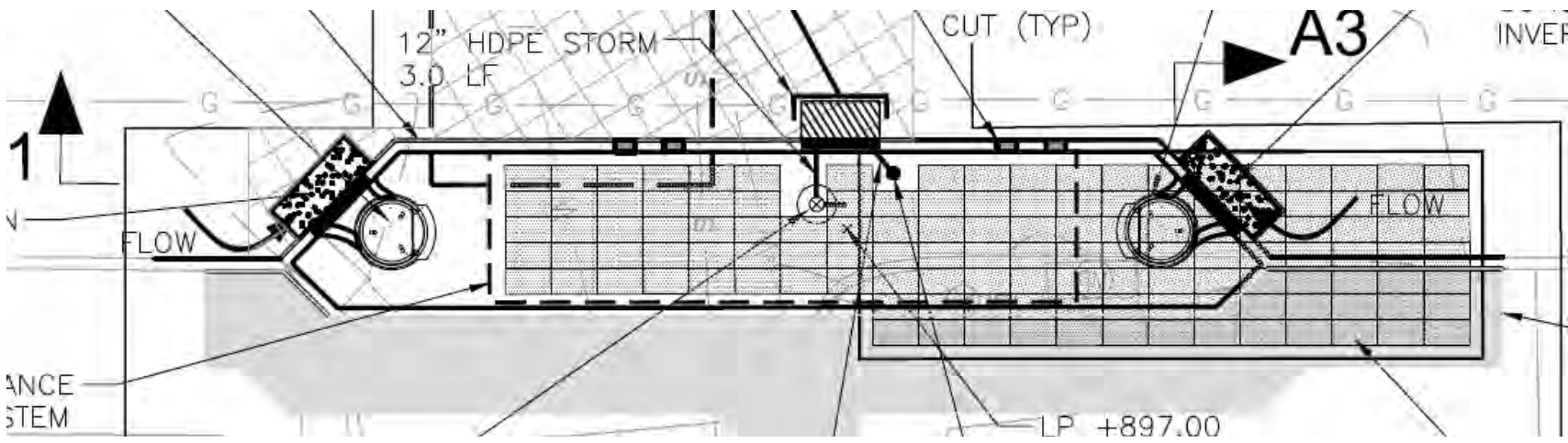

GREEN ROADWAY PROJECTS



HydroCAD[®]

Stormwater Modeling

Click to close screen now

FERGUSON
WATERWORKS

HYDROCAD

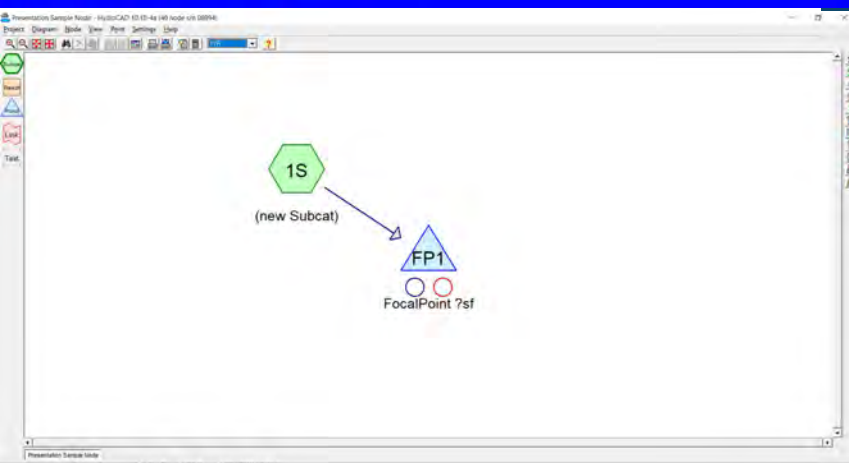

Pond FP1: FocalPoint ?sf - Presentation S...
Summary Hydrograph Discharge Storage Events Sizing

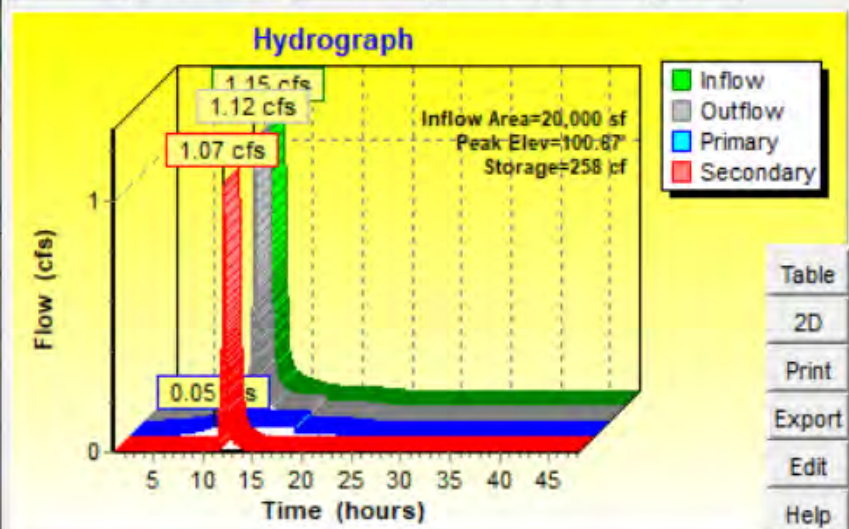

Current Messages
[13] Note: Time span=1.00-48.00 hrs, dt=0.01 hrs, 4701 points
[16] Note: Runoff by SCS TR-20 method, UH=SCS, Weighted-CN
[19] Note: Type III 24-hr 1YR Rainfall=2.60"
[22] Note: Reach routing by Dyn-Stor-Ind method
[25] Note: Pond routing by Dyn-Stor-Ind method
[28] Note: Updating Pond FP1: FocalPoint ?sf
Print Group Show All Help

BASIC MODEL SET UP

SAMPLE NODE

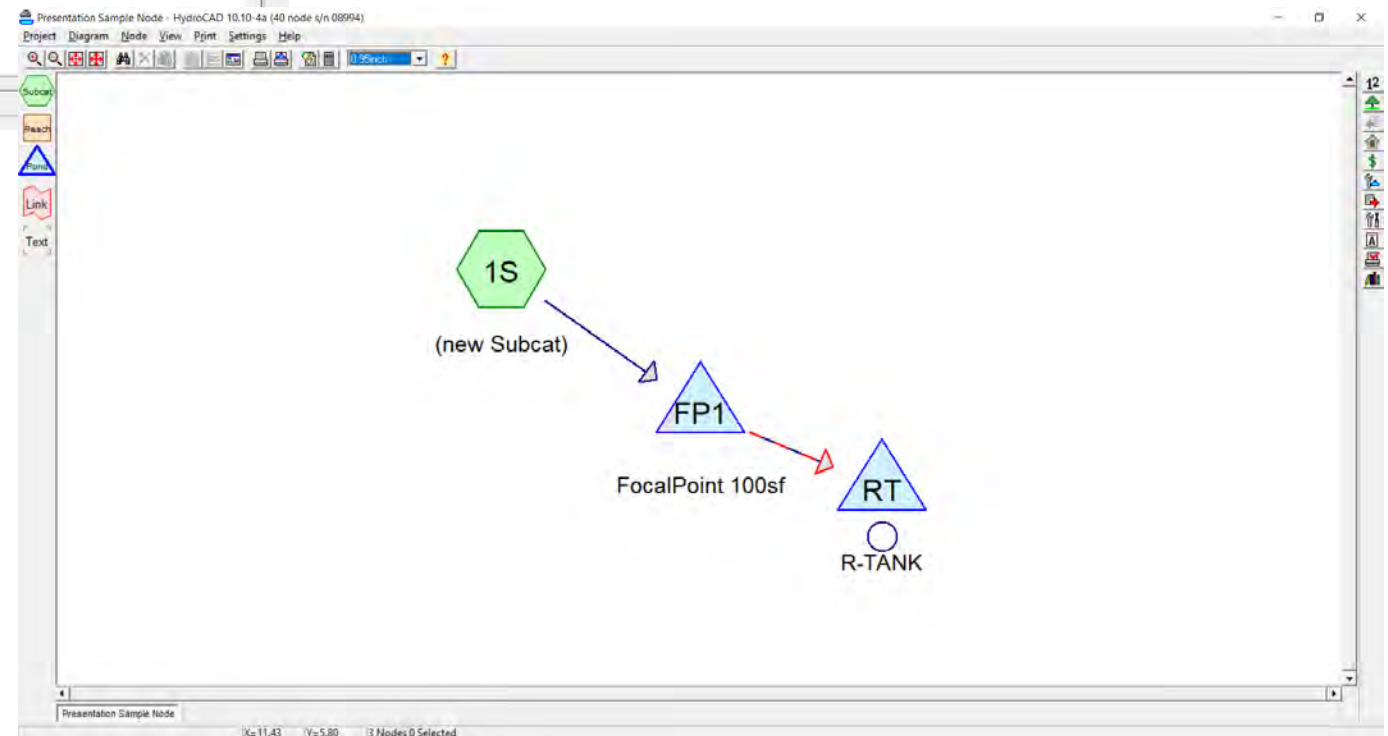
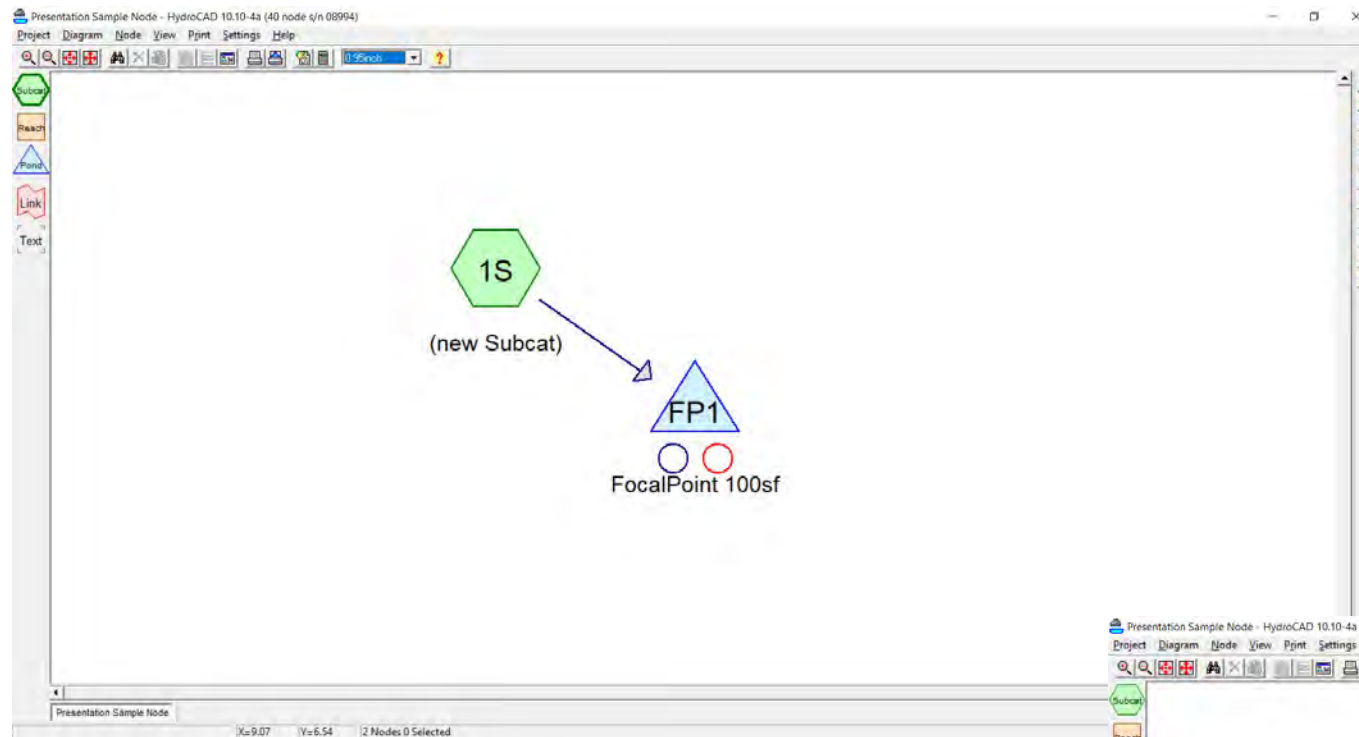

STORAGE AND OUTLET INPUTS

FOCALPOINT NODE INPUT

TWO STORAGE INPUTS

Tip: When embedding storage chambers, enter the outer storage volume FIRST. Click here for details.

Use Large units

OK Cancel Apply Help

#	Invert (feet)	Description	Inside
1	97.75	FocalPoint	
2	100.00	Surface Bowl	
3			
4			
5			
6			
7			
8			
9			

TWO OUTLET INPUTS

Tip: For standpipes and other compound outlets, enter the final outlet device FIRST. Click here for details.

OK Cancel Apply Help

#	Invert (feet)	Description	Routing
1	97.75	Flow through media	Primary
2	100.50	Domed Overflow	Secondary
3			
4			
5			
6			
7			
8			
9			

ONLY MODEL R-TANK IF NEEDED CHANNEL PROTECTION OR FLOOD CONTROL

CAD SUPPORT

DESIGN AND SIZING SUPPORT

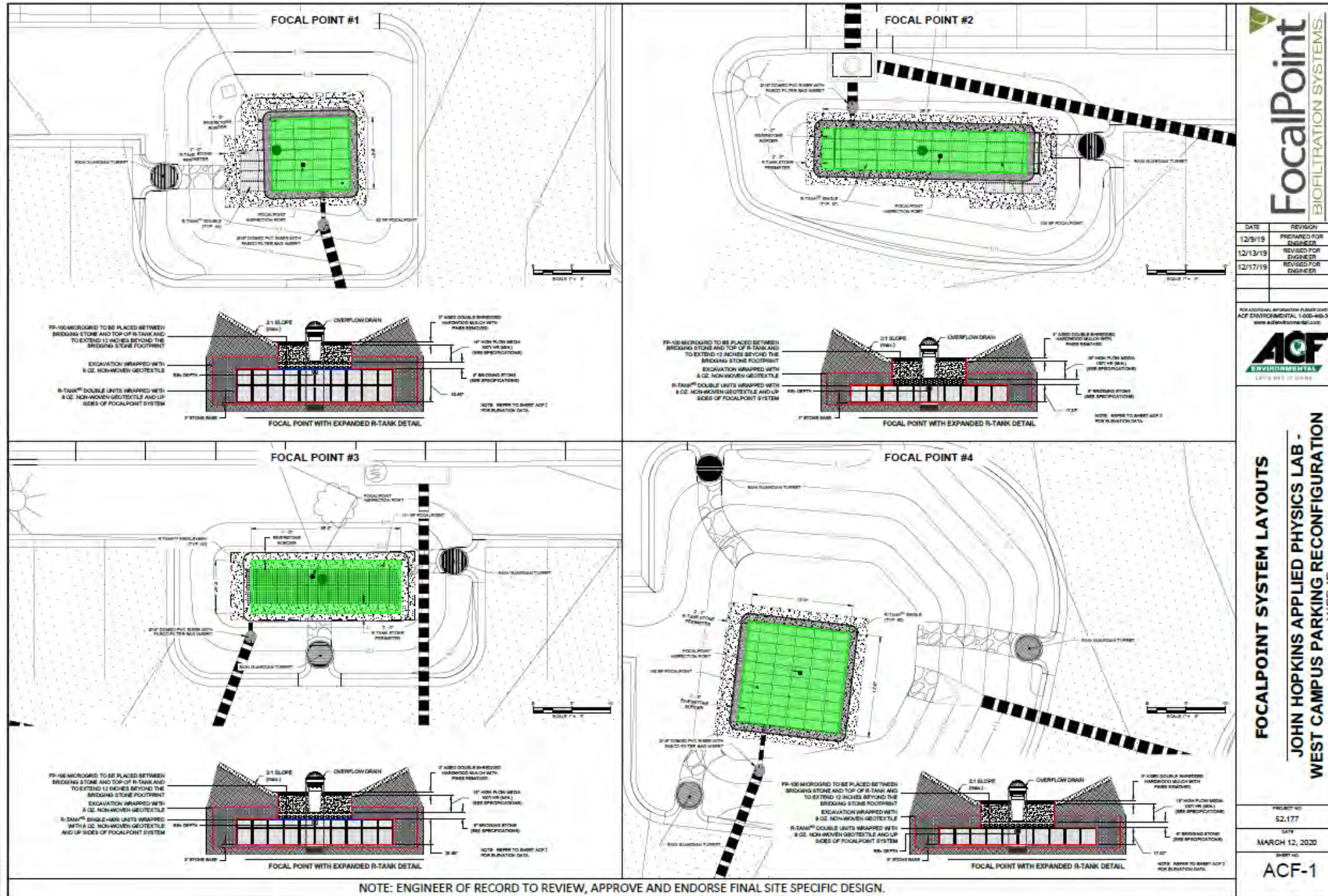

Thank you!!



 **FERGUSON**



(689) 206-4499



Chris.Bogdan@Ferguson.com



Ferguson.com



12500 Jefferson Ave
Newport News VA